

1 UPS 32-70 180



: 96621355

, PES/PP.

1-

: 2 .. 95 °C
 20 °C
 998.2 / ³

TF

95
 : AAA,EAC

EN-JL1030
 ASTM 30 B
 , PES/PP

10
 G 2
 PN 10
 180

C : 2.5
 1: 95
 2: 120
 3: 140
 : 50 Hz
 : 1 x 230 V
 1: 0.45 A
 2: 0.56 A
 3: 0.62 A
 - : 2.5
 (IEC 34-5): IP44
 (IEC 85): H
 :
 :
 :
 : 2.6
 : 2.8
 : 0.004 3

96621355 UPS 32-70 180 50

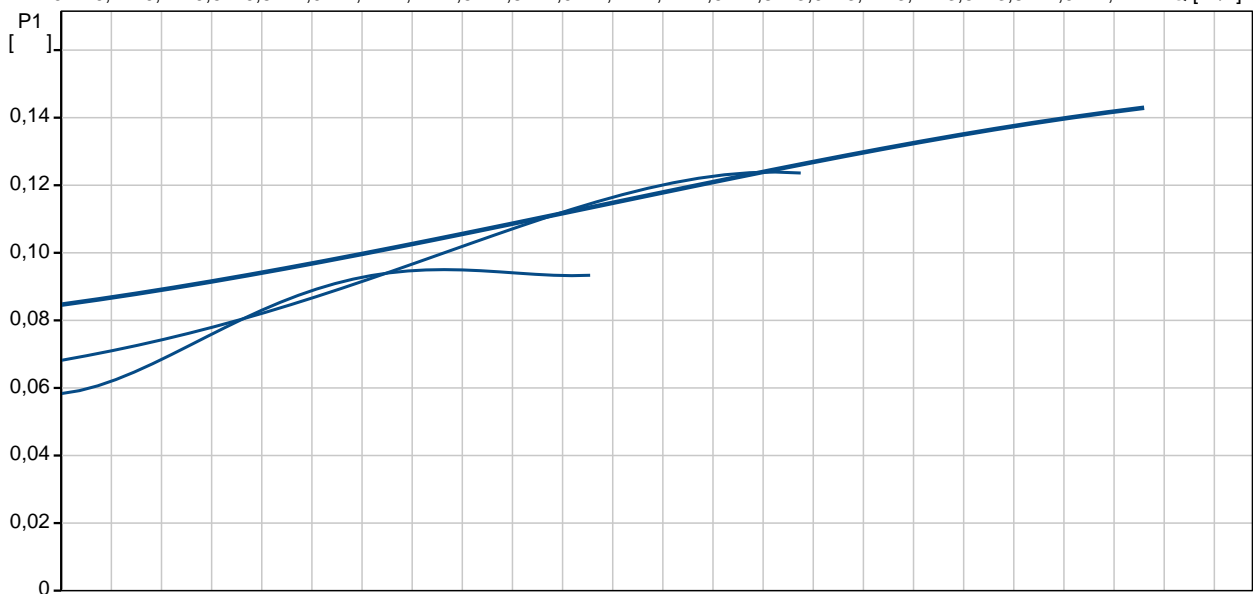
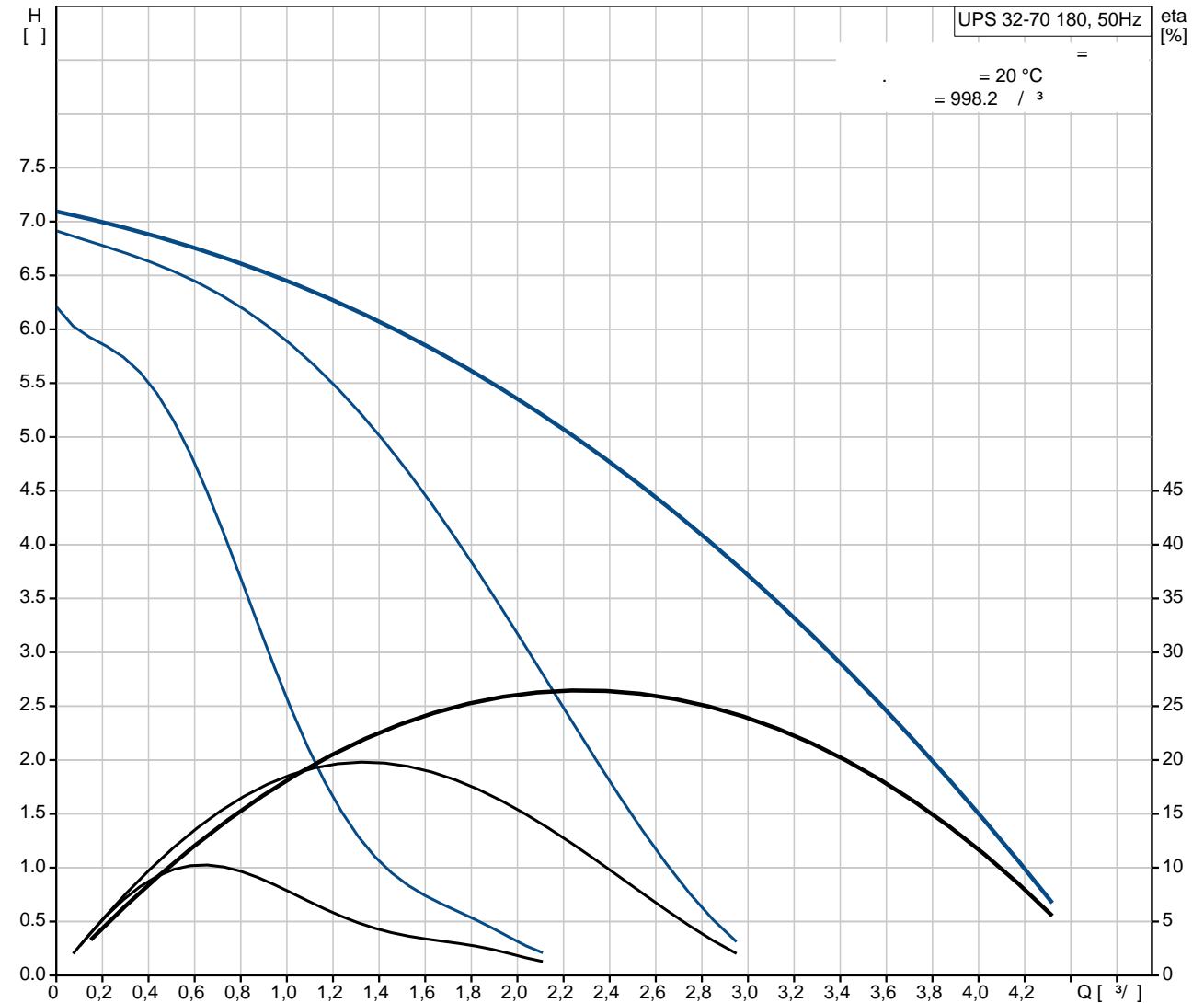

UPS 32-70 180
 EAN : 96621355
 : 5700834972706

TF : 3
 : 70
 : 95
 : AAA,EAC

EN-JL1030
 ASTM 30 B
 , PES/PP

10
 G 2
 PN 10
 180

2 .. 95 °C
 20 °C
 998.2 / 3

C : 2.5
 95
 1: 120
 2: 140
 3: 50 Hz
 : 1 x 230 V
 1: 0.45 A
 2: 0.56 A
 3: 0.62 A
 : 2.5
 (IEC 34-5): IP44
 (IEC 85): H

2.6
 2.8
 0.004 3

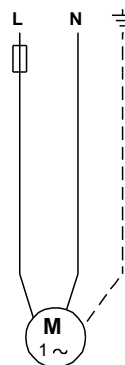
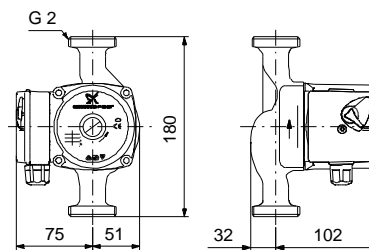
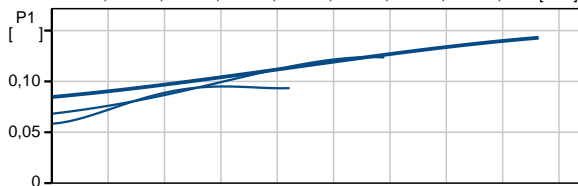
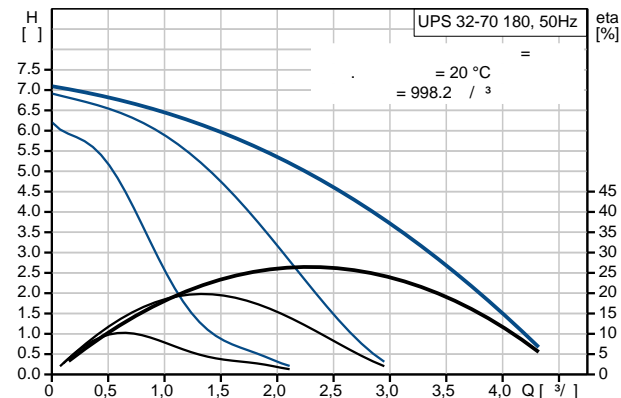

96621355 UPS 32-70 180 50

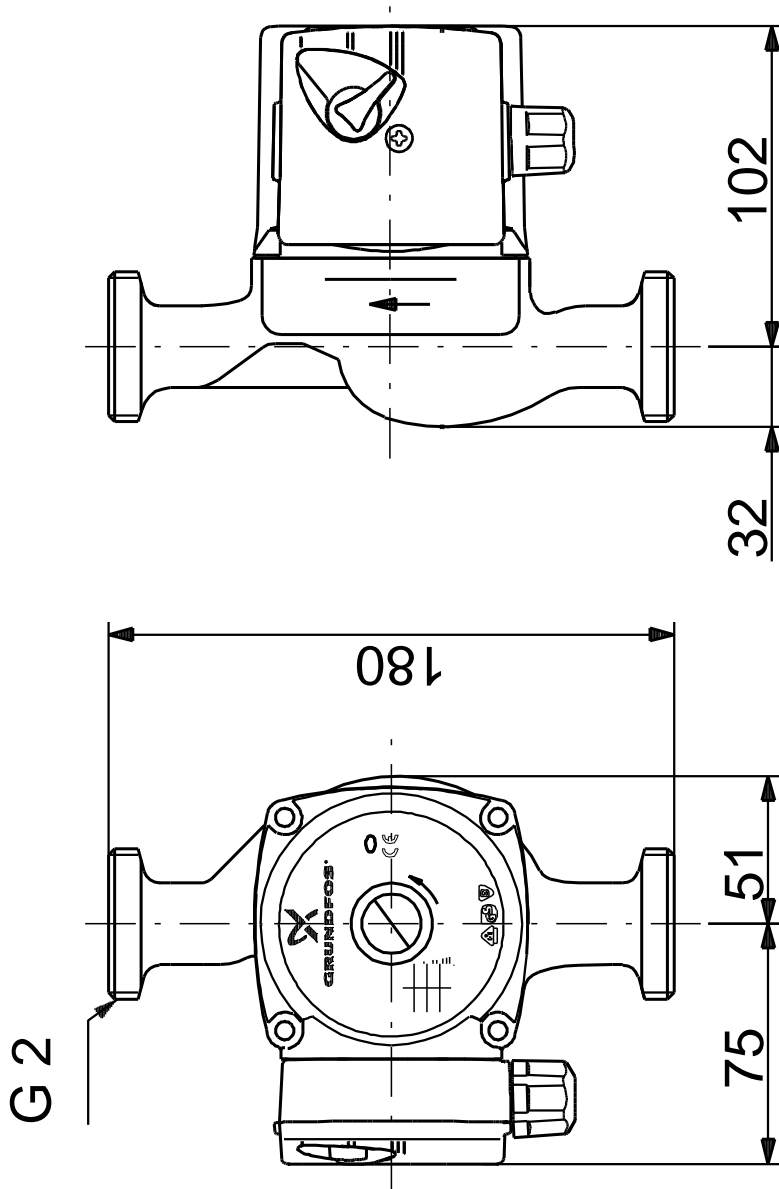

96621355 UPS 32-70 180 50

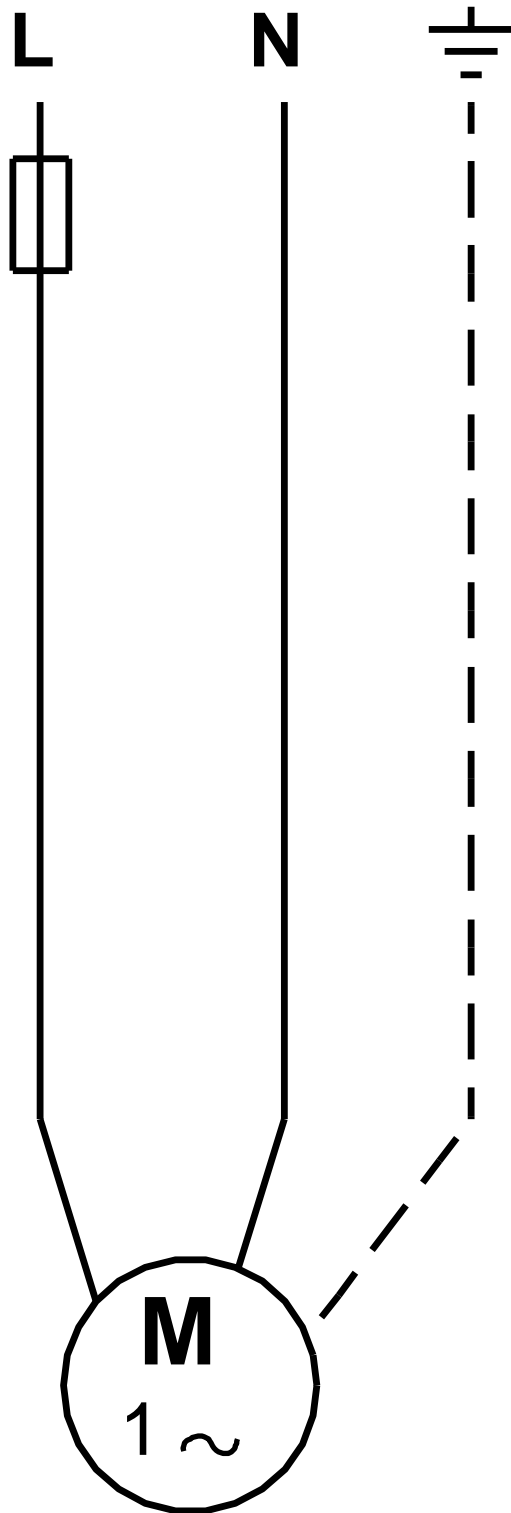

! []