

1 ALPHA2 L 25-60 180



: [95047564](#)

GRUNDFOS ALPHA2 L

ALPHA2 L -

Grundfos.

ALPHA2 L

ALPHA2 L

«A»

Grundfos.

ALPHA2 L

«A»

ALPHA2 L
80 %

. ALPHA2 L
«D».

ALPHA

ALPHA

: 2 .. 110 °C

TF

110

: VDE,GS,CE

EN-JL 1020
ASTM A48-25 B

, PP

: 0 .. 40 °C

10
G 1 1/2
PN 10
180

..-P1: 5 .. 45
: 0.05 .. 0.38 A
: 50 Hz
: 1 x 230 V
(IEC 34-5): IP42
(IEC 85): F

95047564 ALPHA2 L 25-60 180 50

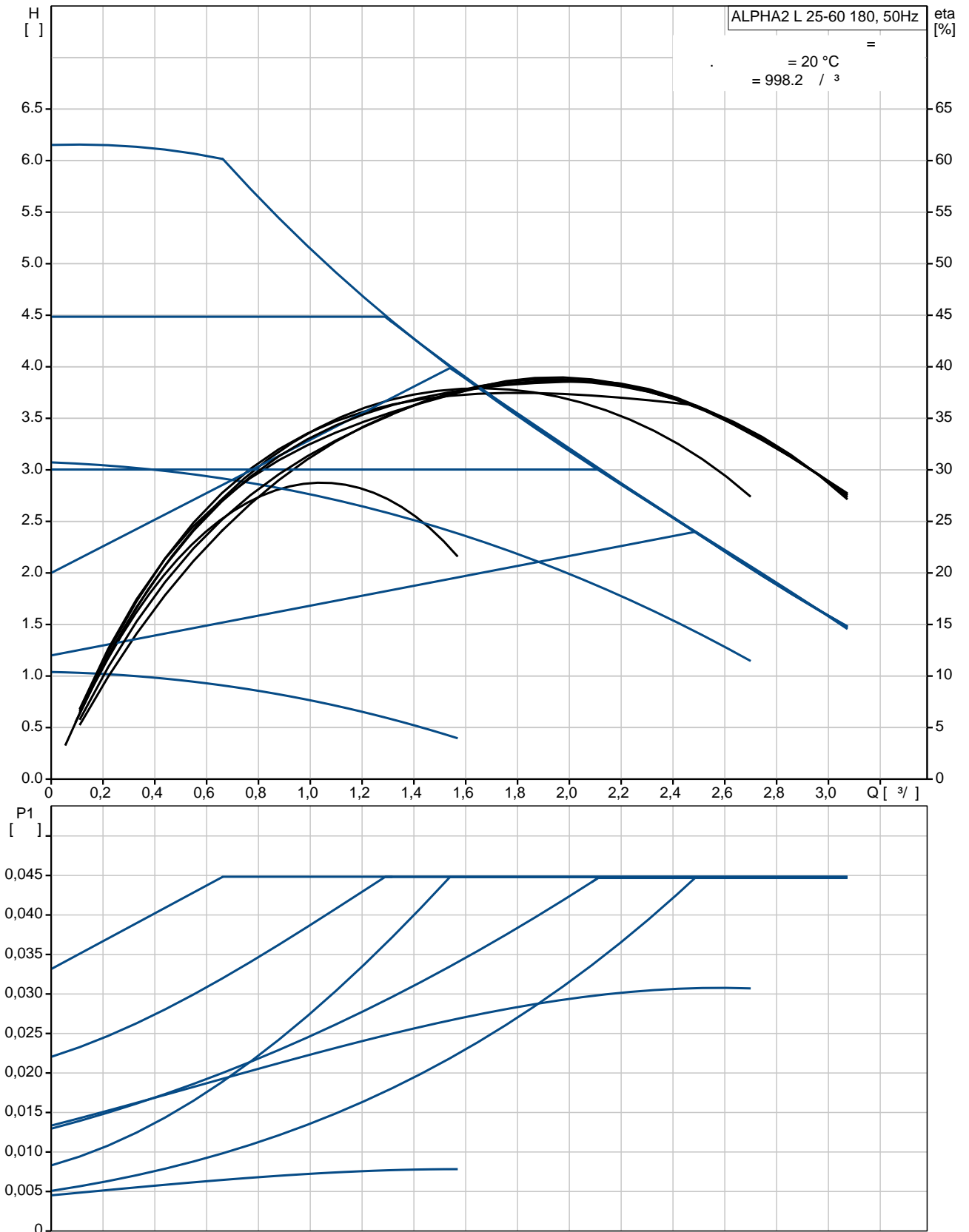

ALPHA2 L 25-60 180	
EAN: 95047564	
EAN: 5700311668597	
TF	60
	110
	VDE,GS,CE
	EN-JL 1020
	ASTM A48-25 B
	, PP
	0 .. 40 °C
	10
	G 1 1/2
	PN 10
	180
	2 .. 110 °C
-P1:	5 .. 45
	0.05 .. 0.38 A
	50 Hz
	1 x 230 V
(IEC 34-5):	IP42
(IEC 85):	F
	ELEC
	6H
(EEI):	0.23
	2.1
	2.3

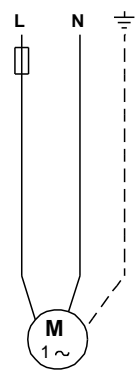
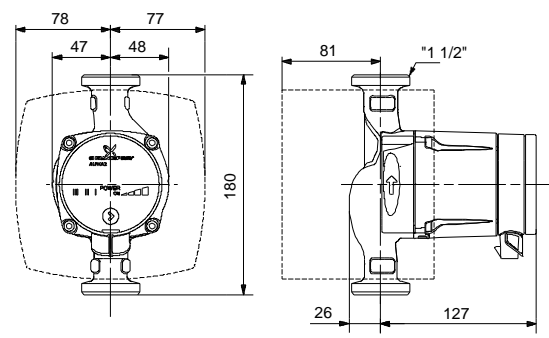
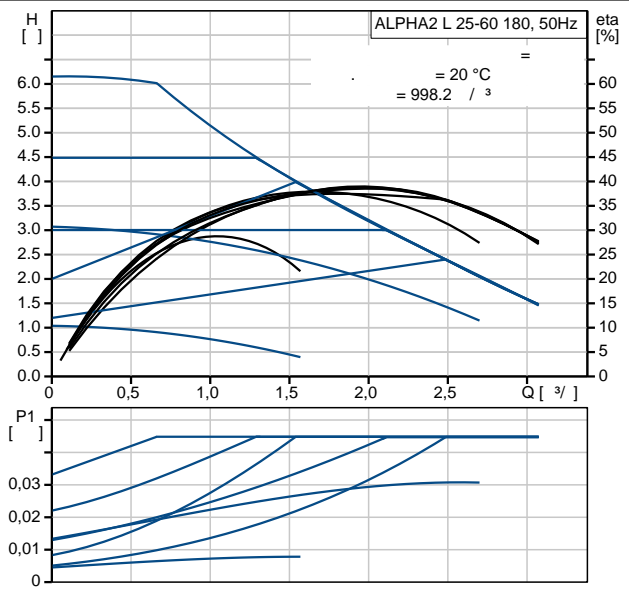

95047564 ALPHA2 L 25-60 180 50

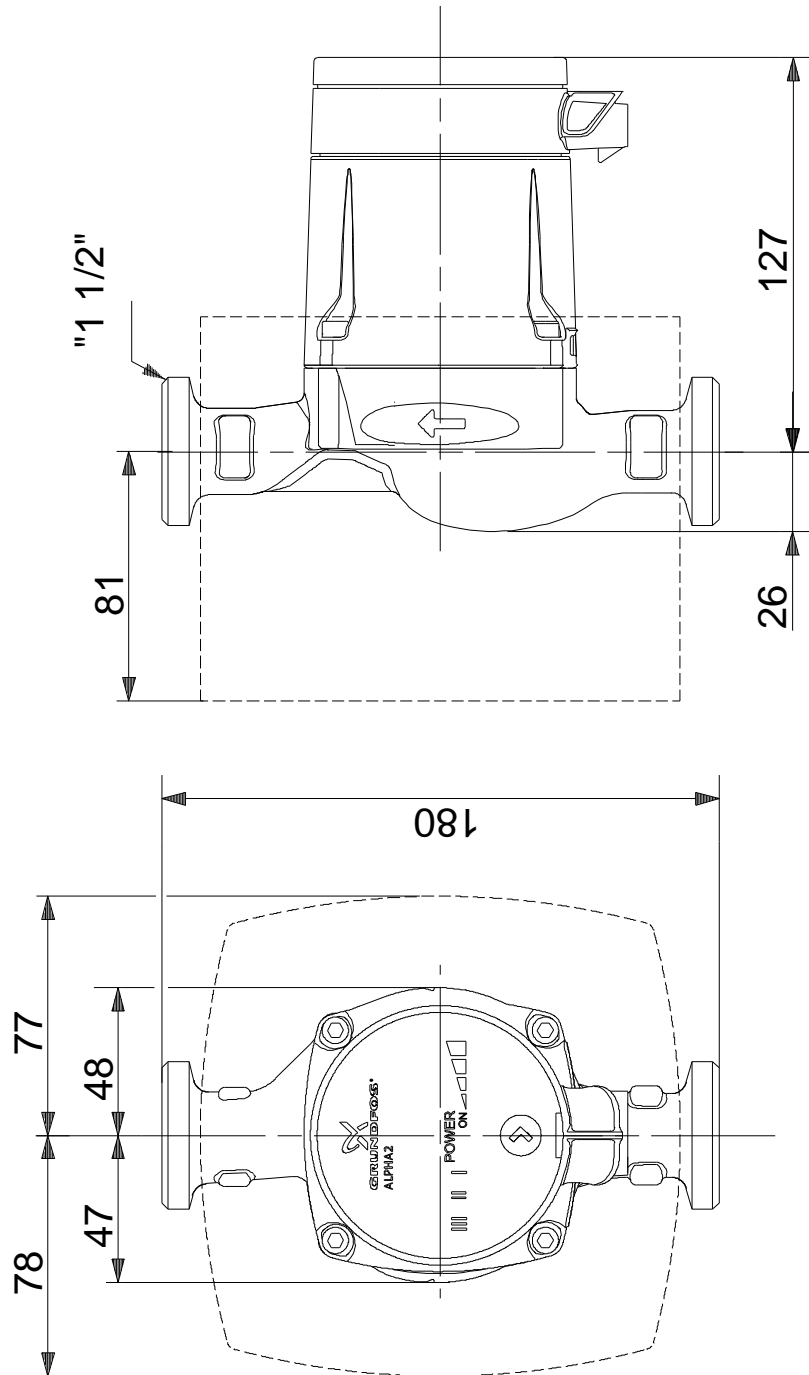

95047564 ALPHA2 L 25-60 180 50

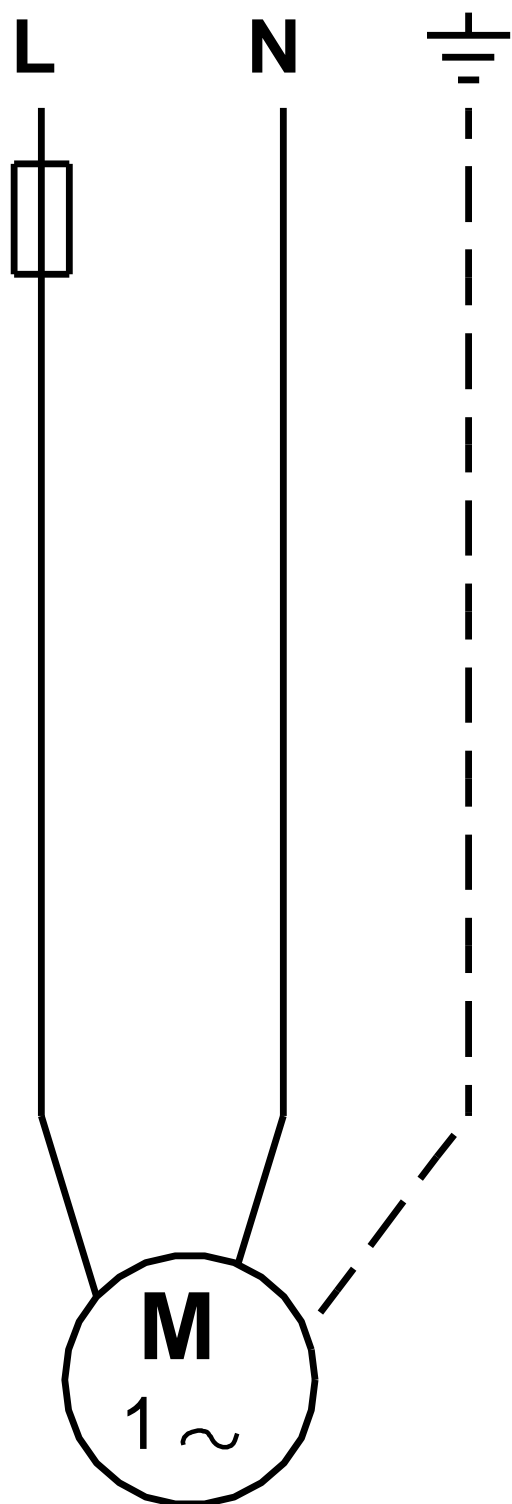

!

[],