

1 Unilift AP12.50.11.1



{_QM_CONTROL}

: 0..55 °C
998.2 / 3

: 12

DIN W.-Nr. 1.4301

		AISI 304
		DIN W.-Nr. 1.4301
		AISI 304
		Rp 2
		: 7
		PSC
		- P1: 1.7
		: 50 Hz
		: 1 x 230
		: 8.5 A
Cos phi -	-	: 0,92
		: 2760 /
		: 20 /400
	(IEC 34-5):	IP68
	(IEC 85):	F
		: 10
		: SCHUKO
		15.7
		16.5
	Danish VVS No.:	391313112
	Swedish RSK No.:	5885782
	Norwegian NRF no.:	NRF NO 9045617

Unilift AP12.50.11.1 50

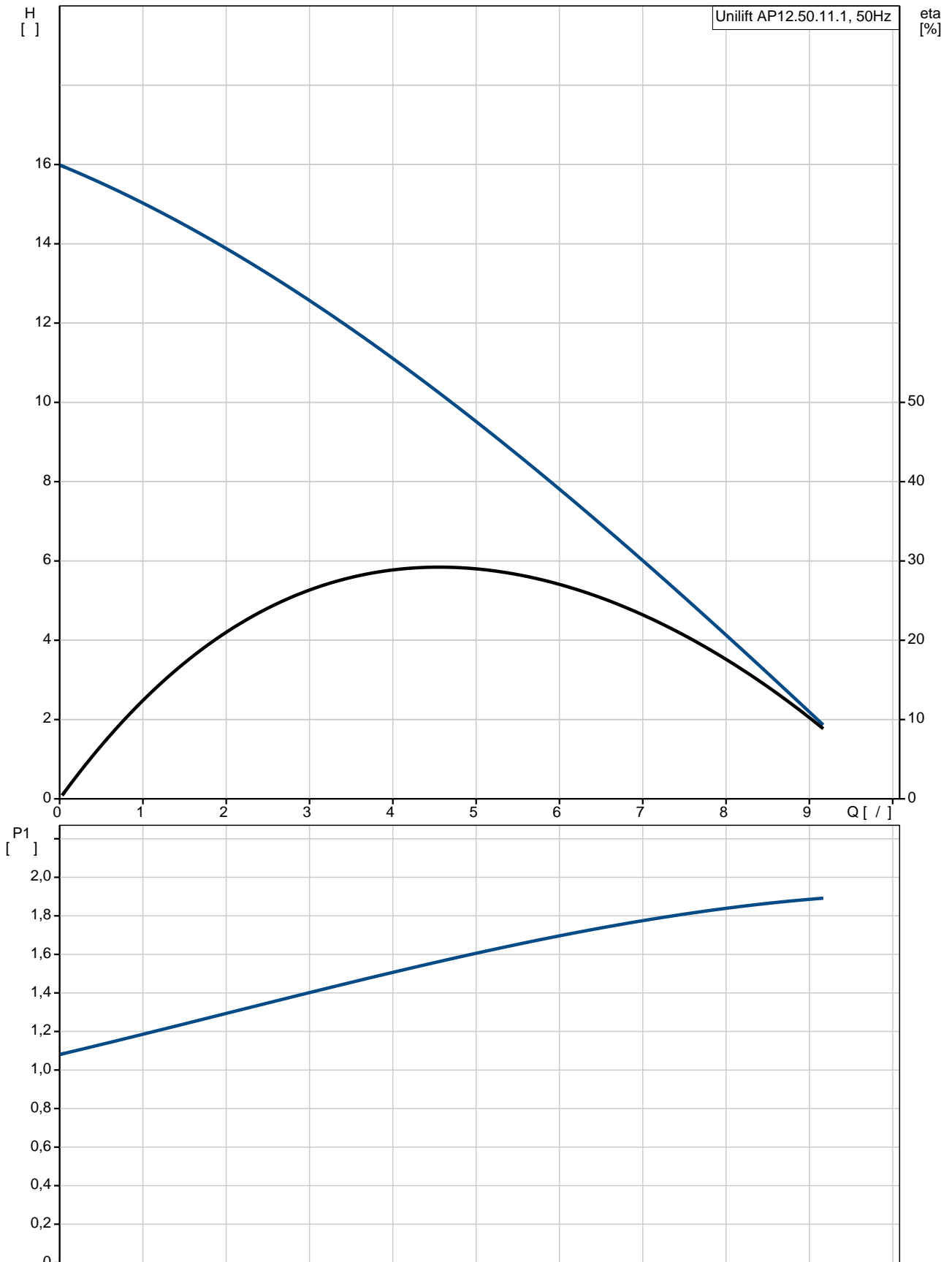

Unilift AP12.50.11.1

EAN :

Ma : 8.33 /

17

12

DIN W.-Nr. 1.4301
AISI 304

DIN W.-Nr. 1.4301
AISI 304

Rp 2

7

D/S

0 .. 55 °C

998.2 / ³

PSC

- P1: 1.7

P2: 1.1

50 Hz

1 x 230

8.5 A

Cos phi - : 0,92

2760 /

20 /400

(IEC 34-5): IP68

(IEC 85): F

CONTACT

10

SCHUKO

15.7

16.5

Danish VVS No.: 391313112

Swedish RSK No.: 5885782

Norwegian NRF no.: NRF NO 9045617

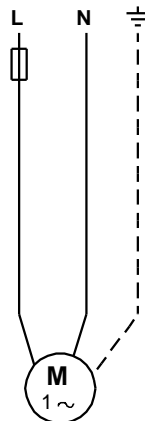
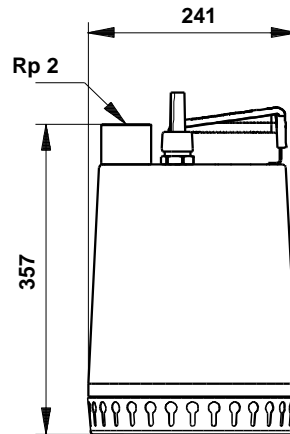
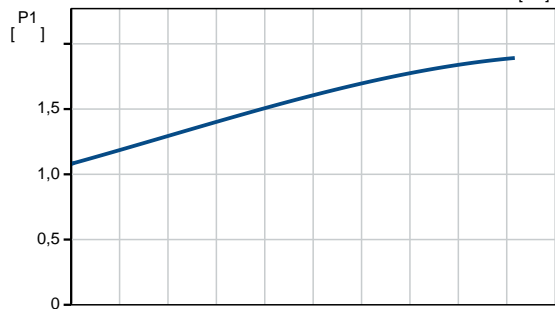
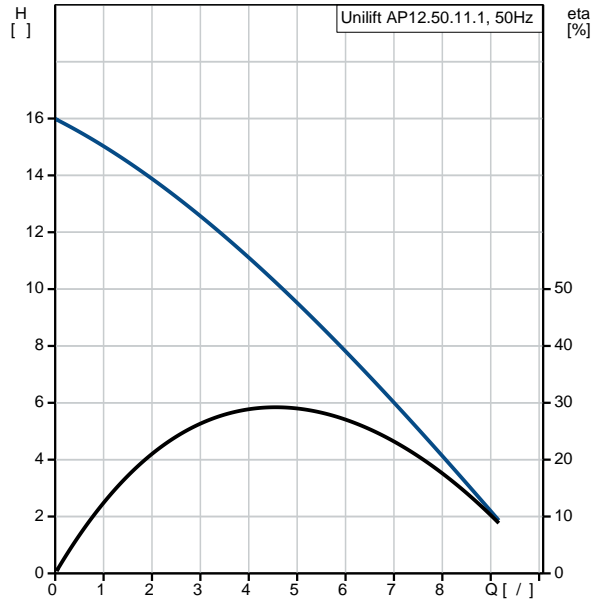

Unilift AP12.50.11.1 50

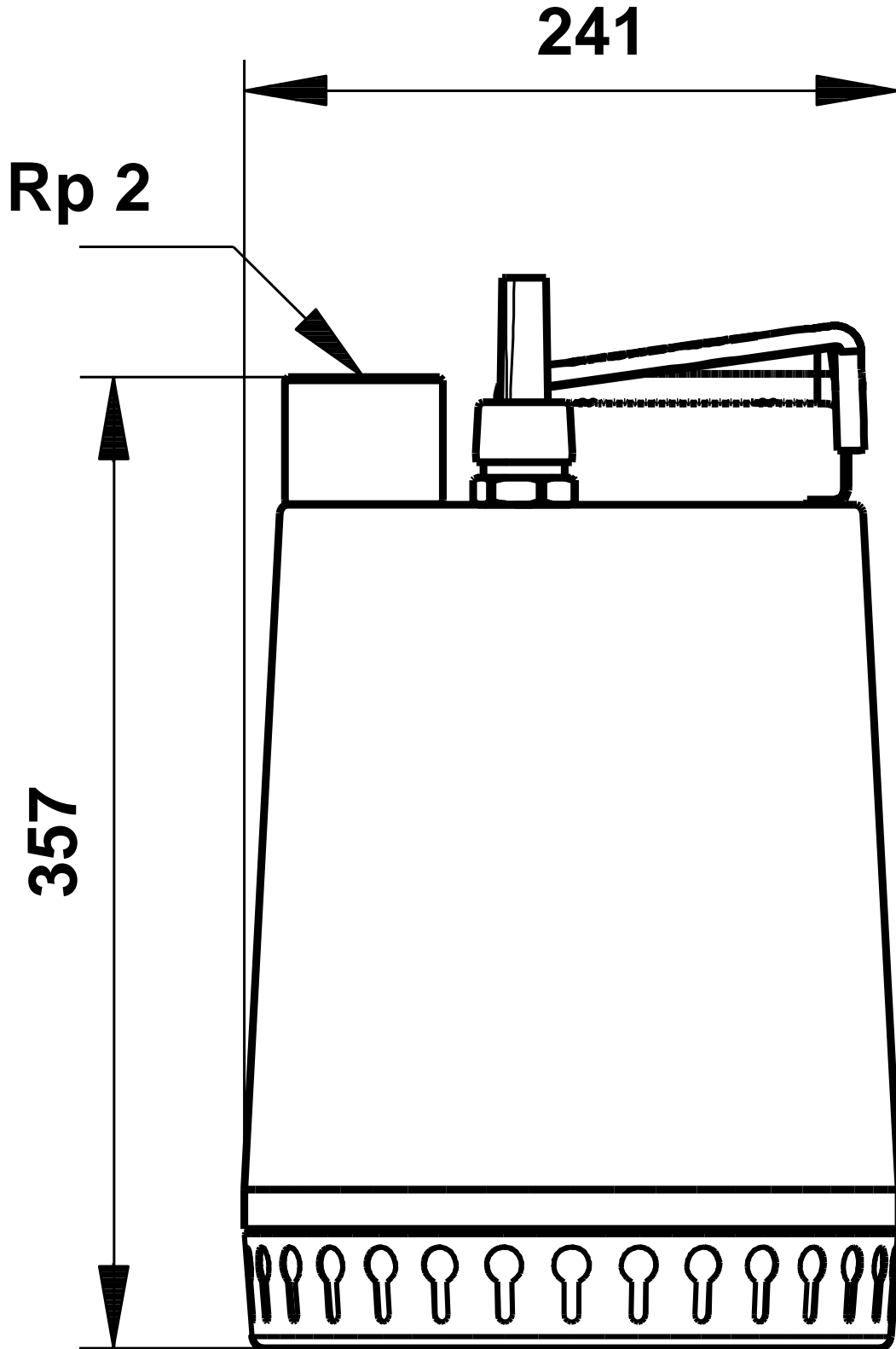

Unilift AP12.50.11.1 50

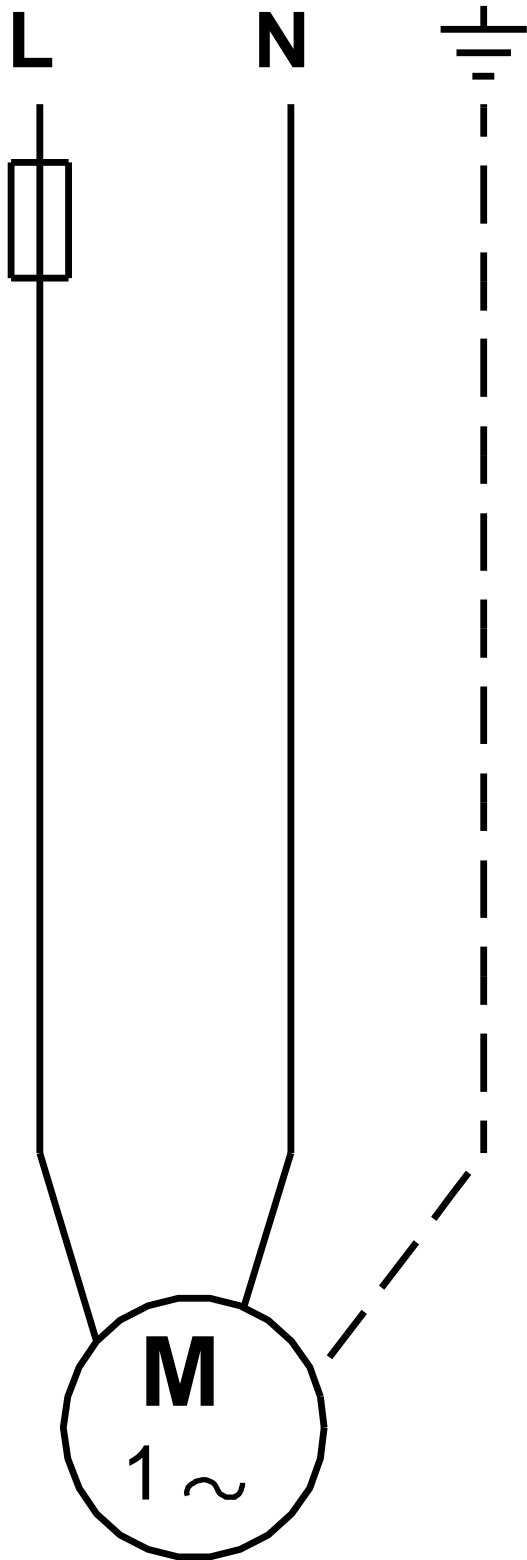

! [], .