

1 KPC 300 A



The KPC 300 and 600 are designed mainly for automatically operated, permanent domestic applications for draining basements and garages, which are subject to flooding. Thanks to its compact, easy-to-handle design, it can also be used as a portable pump for emergencies such as lifting water from tanks or rivers, emptying swimming pools, fountains, excavations and underpasses. It is also ideal for gardening and hobbies in general. The level switch allows permanent installation and guarantees automatic pump operation.

: 0 .. 35 °C  
 : 998.2 / 3  
 : 10  
 : GFN2 ( ) GFN2  
 : Rp 1 1/4 : 7  
 C : - P1: 350  
 : 8  
 : 50 Hz  
 : 1 x 220-240 V  
 : 1.5 A  
 : 8 /450 V  
 (IEC 34-5): IP68  
 (IEC 85): F  
 : 10  
 : SCHUKO  
 : 4.1  
 : 4.6  
 : 0.016 3

## KPC 300 A 50

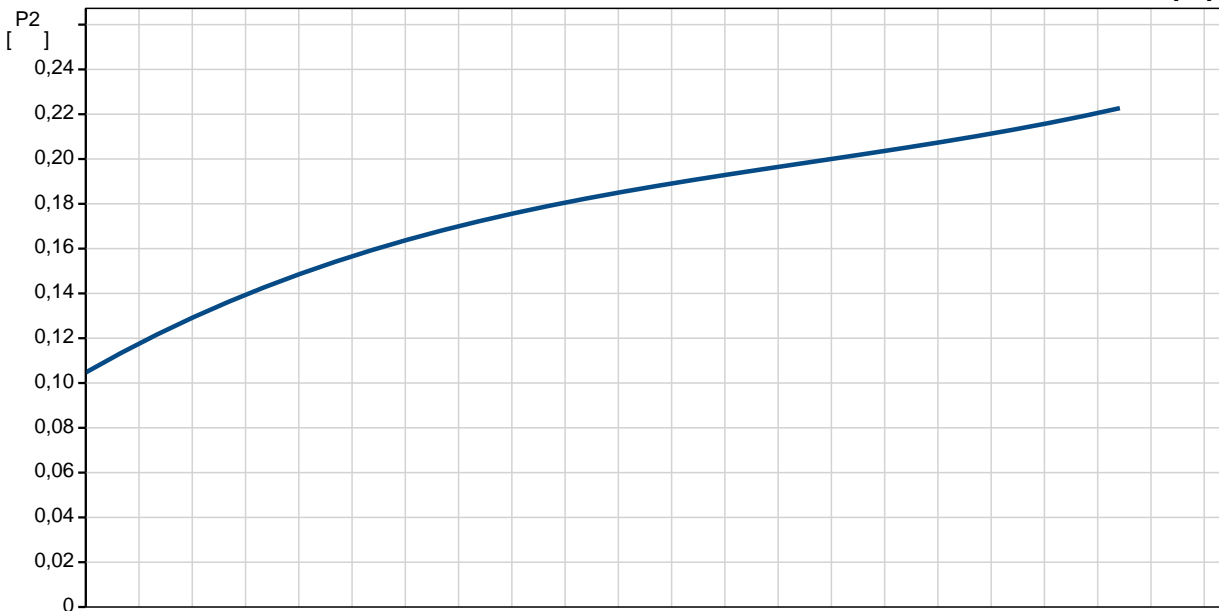
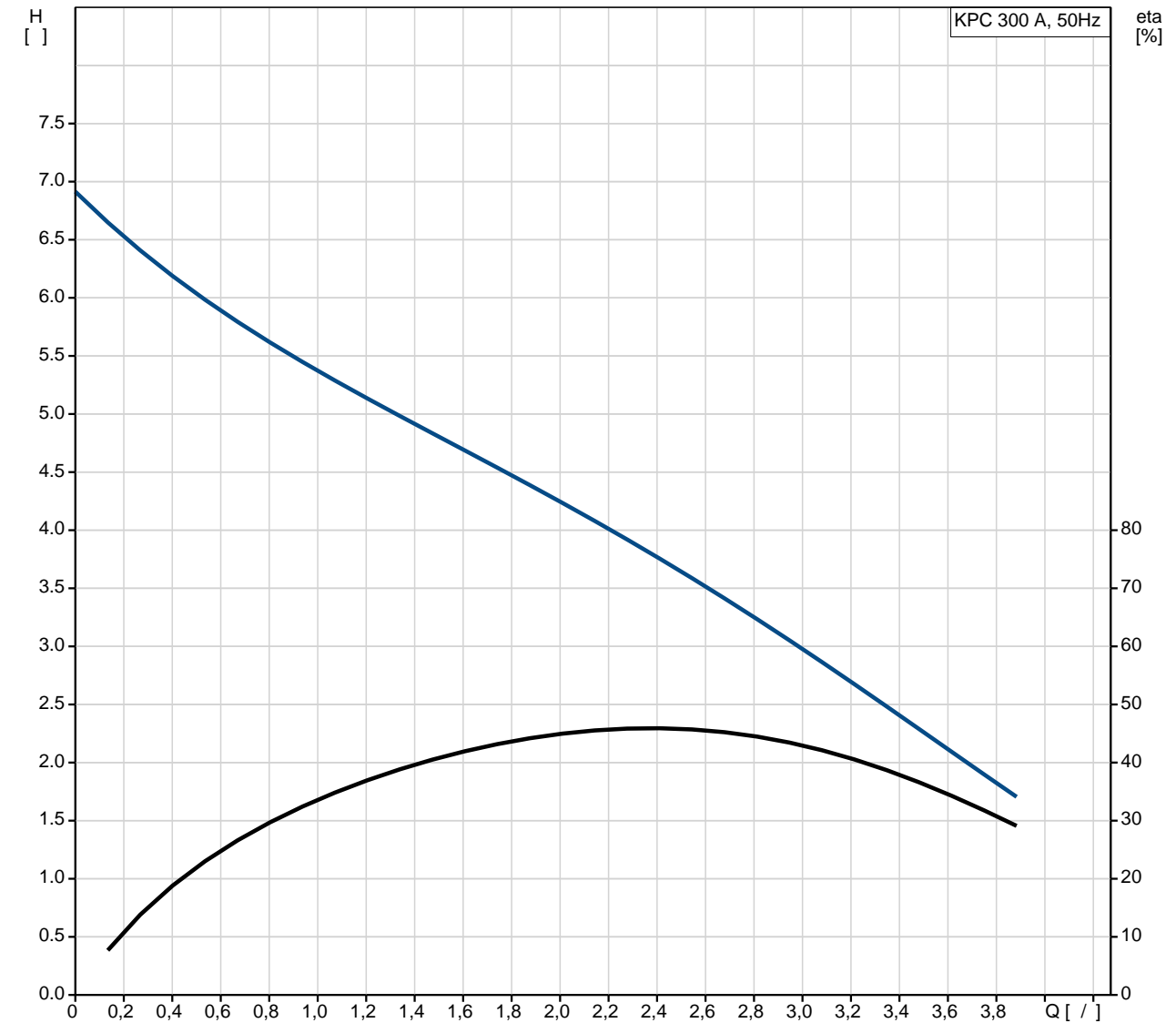

KPC 300 A	
EAN	
Ma	3.61 /
	6.5
	10
	A
GFN2	
	GFN2 ( )
	Rp 1 1/4
	7
	0 .. 35 °C
	998.2 / <sup>3</sup>
C	- P1: 350
	8
	50 Hz
	1 x 220-240 V
	1.5 A
	8 /450 V
	(IEC 34-5): IP68
	(IEC 85): F
	10
	SCHUKO
	A/WITH
	4.1
	4.6
	0.016 <sup>3</sup>

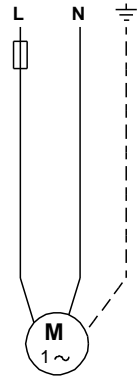
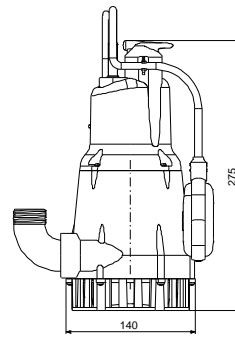
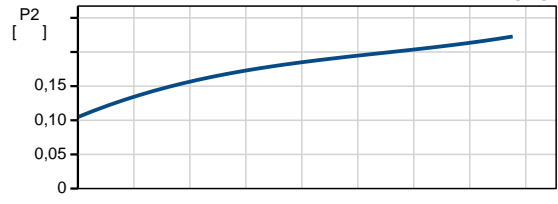
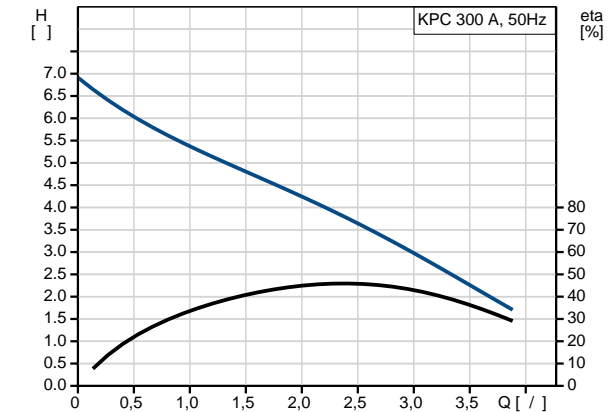

**KPC 300 A 50**

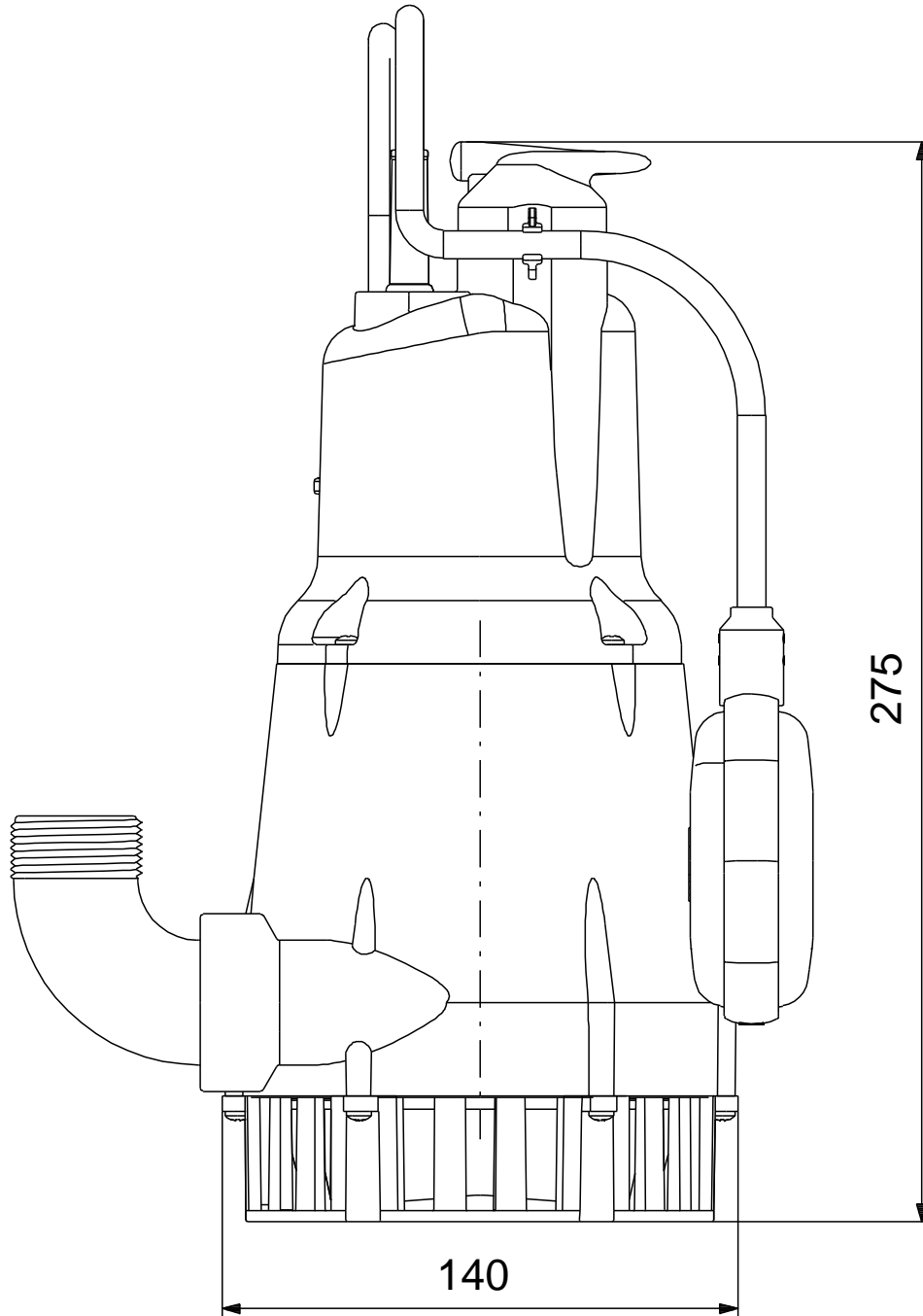

**KPC 300 A 50**

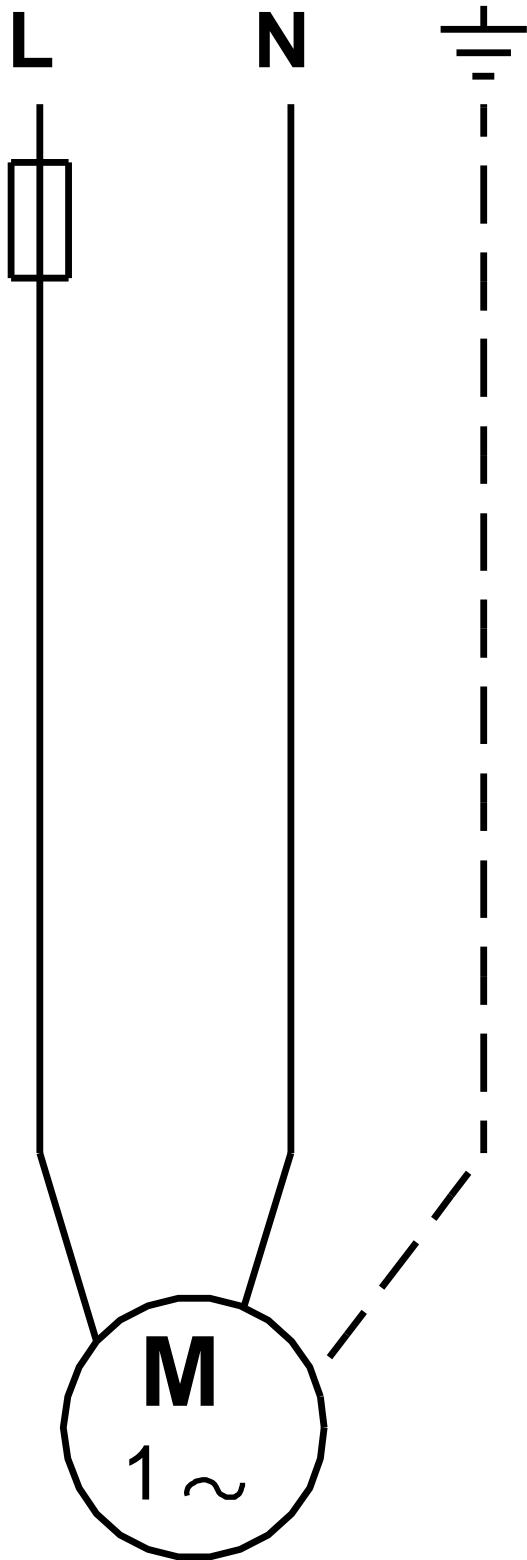

! [ ], .