

1 MAGNA1 40-120 F



MAGNA1 -

MAGNA1

MAGNA1

EuP.

: -10 .. 110 °C  
 : 60 °C  
 : 983.2 / 3

TF : 110  
 : CE,VDE,EAC

EN-GJL-250  
 ASTM A48-250B  
 PES 30%GF

: 0 .. 40 °C

: 10  
: DIN  
: DN 40  
: PN6/10  
: 250  
:  
-P1: 15.01 .. 463  
: 50 Hz  
: 1 x 230  
: 0.18 .. 2.05 A  
(IEC 34-5): X4D  
(IEC 85): F

:  
: (EEI): 0.21  
: 16.2  
: 17.7  
: 39.6 <sup>3</sup>

## MAGNA1 40-120 F 50

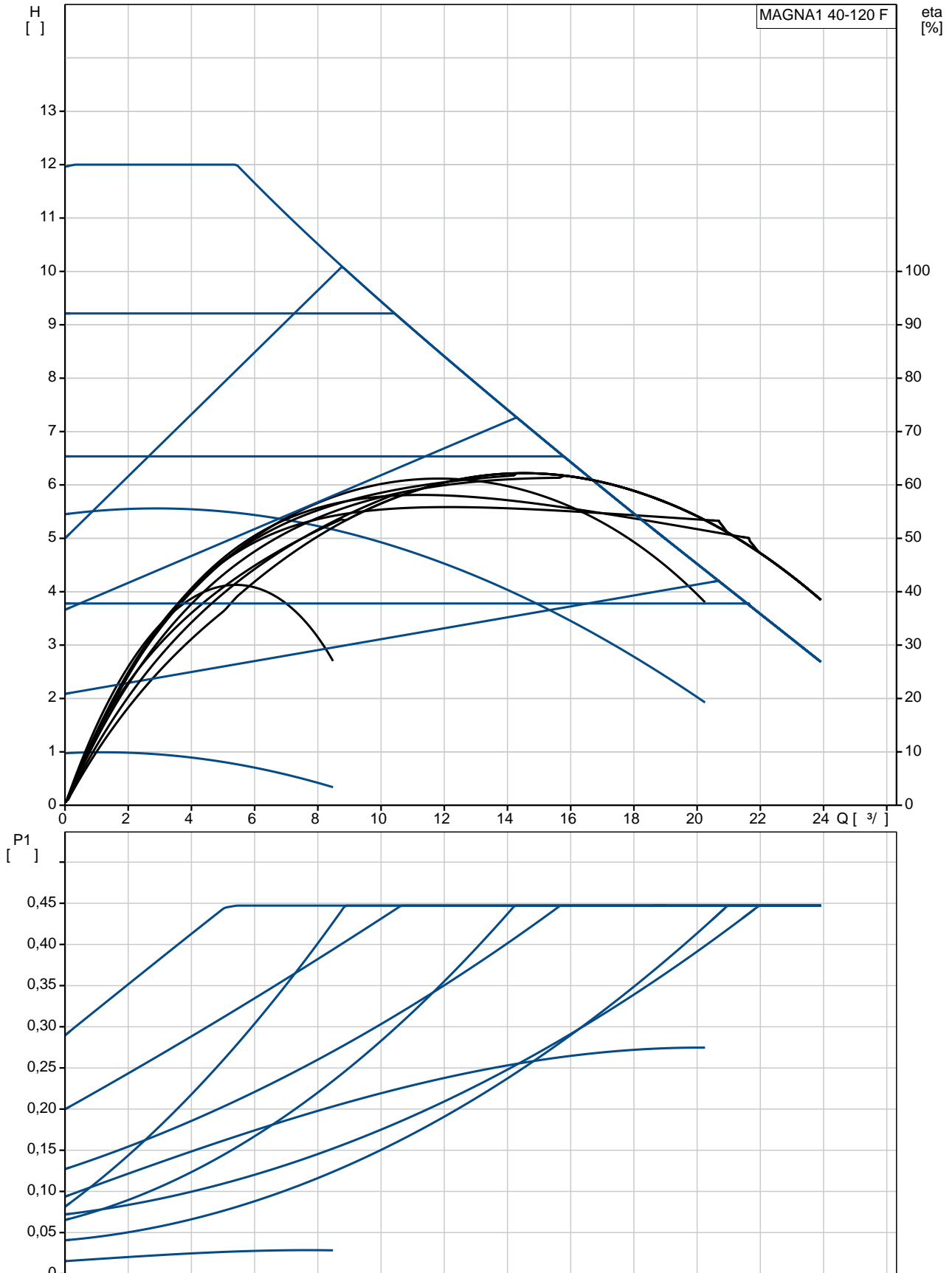

MAGNA1 40-120 F

EAN :

TF :

120  
110  
CE, VDE, EAC  
B

EN-GJL-250  
ASTM A48-250B  
PES 30%GF

0 .. 40 °C

10  
DIN  
DN 40  
PN6/10  
250

-10 .. 110 °C  
60 °C  
983.2 / 3

-P1: 15.01 .. 463

50 Hz  
1 x 230

0.18 .. 2.05 A

(IEC 34-5): X4D

(IEC 85): F

(EEI): 0.21

16.2

17.7

39.6 3

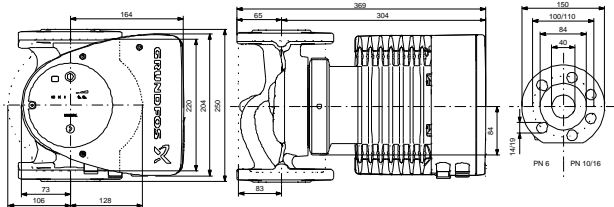
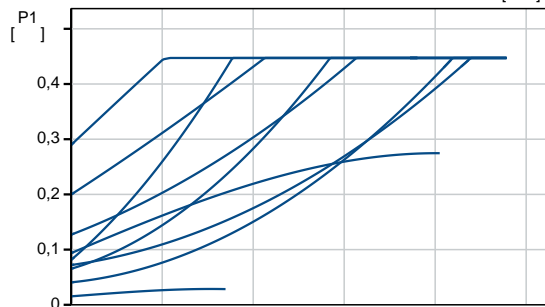
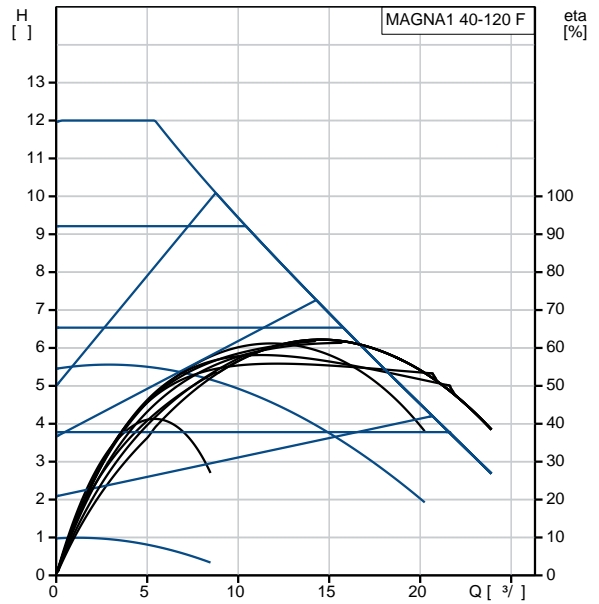

Example of mains-connected motor with mains switch, backup fuse and additional protection

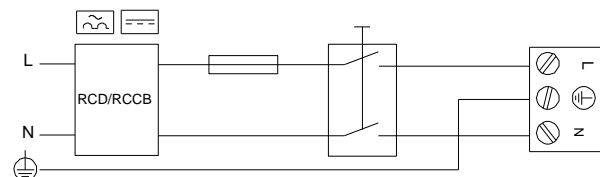

## MAGNA1 40-120 F 50

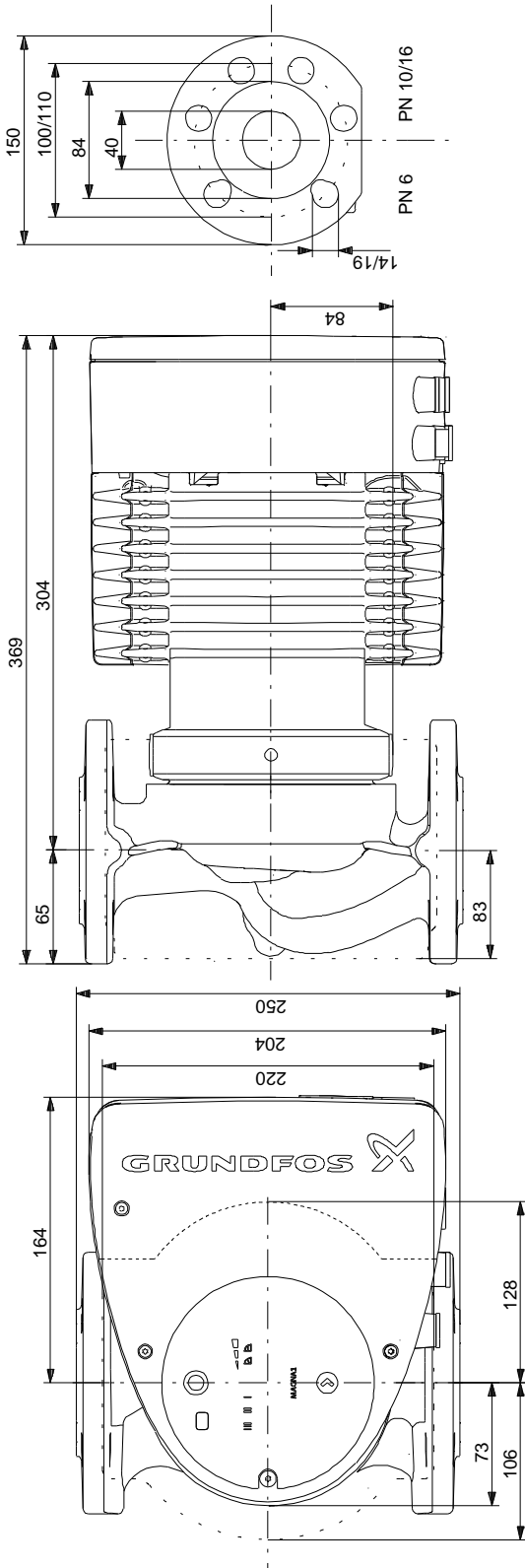

**MAGNA1 40-120 F 50**

Example of mains-connected motor with mains switch, backup fuse and additional protection

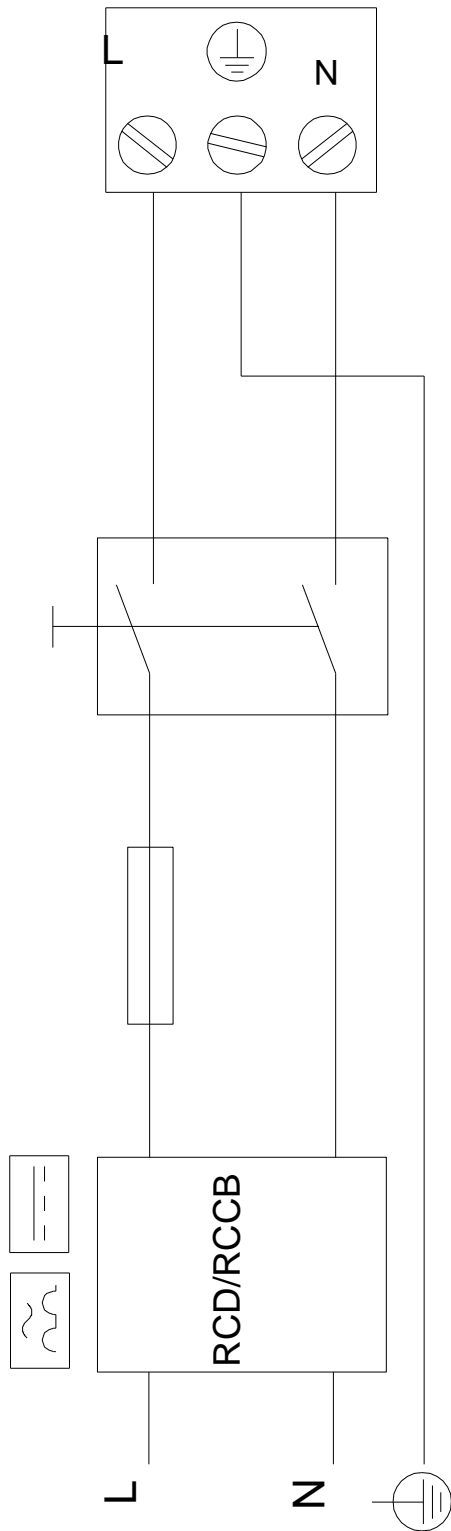

! [ ], .