

1 UPS 32-100 180



: 95906500

3-

- *
- *
- *
- *
- *
- *

, PES/PP.

1-

: -25 .. 110 °C
 20 °C
 998.2 / 3

TF

110
 : CE

EN-JL1030
 ASTM 30 B
 , PES/PP

.T

80 0C: 40 °C

10
 G 2
 PN 10
 180

C

9.5

1: 280
 2: 340
 3: 345

: 50 Hz
 : 1 x 230 V

1: 1.3 A
 2: 1.5 A

3: 1.52 A
 - : 9.5

(IEC 34-5): X4D
 (IEC 85): H

6.4
 6.9
 0.012 3

95906500 UPS 32-100 180 50

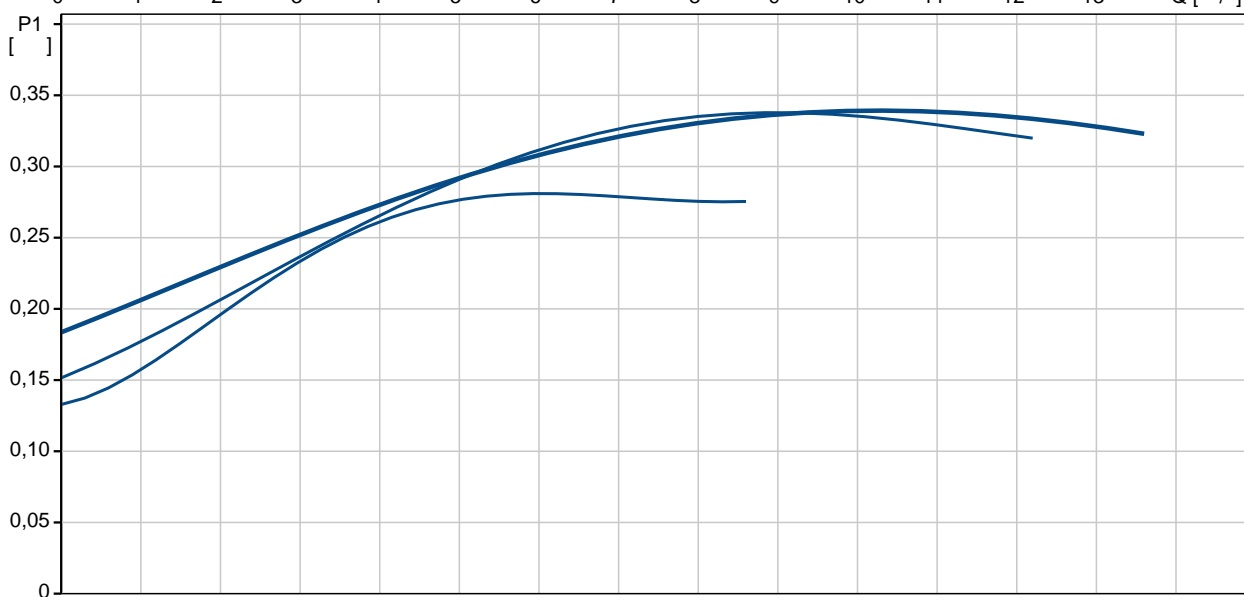
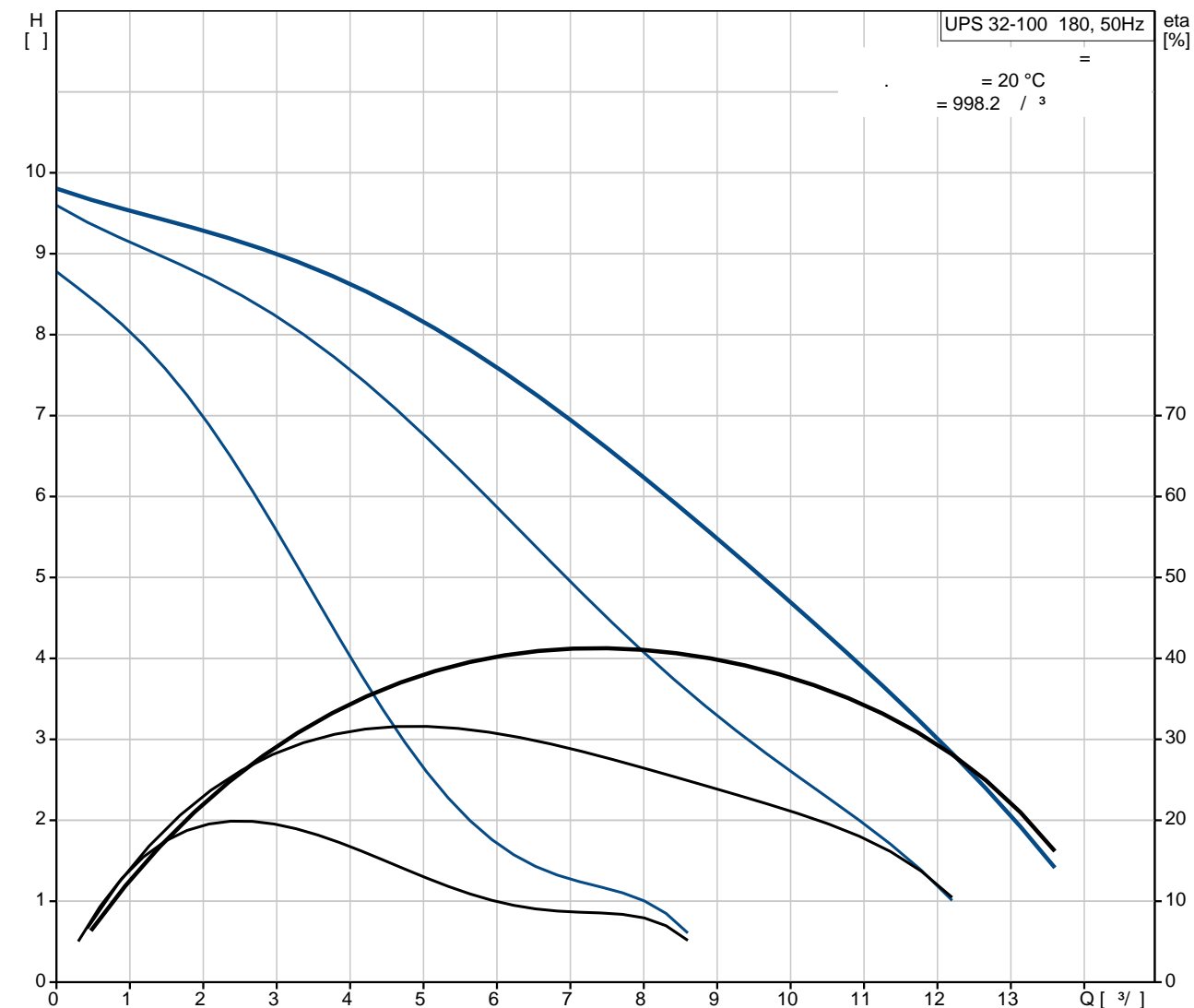

		UPS 32-100 180
		95906500
EAN		5700312073079
		3
		100
TF		110
		CE
		EN-JL1030
		ASTM 30 B
		, PES/PP
		40 °C
80 OC:		10
		G 2
		PN 10
		180
		-25 .. 110 °C
		20 °C
		998.2 / ³
C		9.5
		1: 280
		2: 340
		3: 345
		50 Hz
		1 x 230 V
		1: 1.3 A
		2: 1.5 A
		3: 1.52 A
		9.5
(IEC 34-5):		X4D
(IEC 85):		H
		Contact
		9H
		6.4
		6.9
		0.012 3

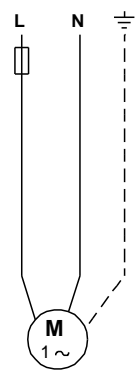
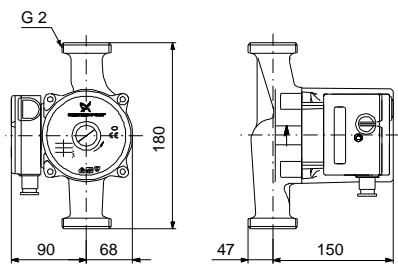
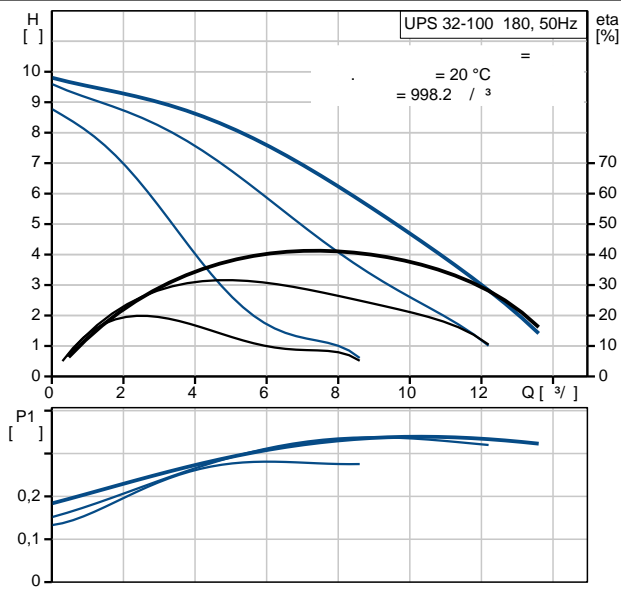

95906500 UPS 32-100 180 50

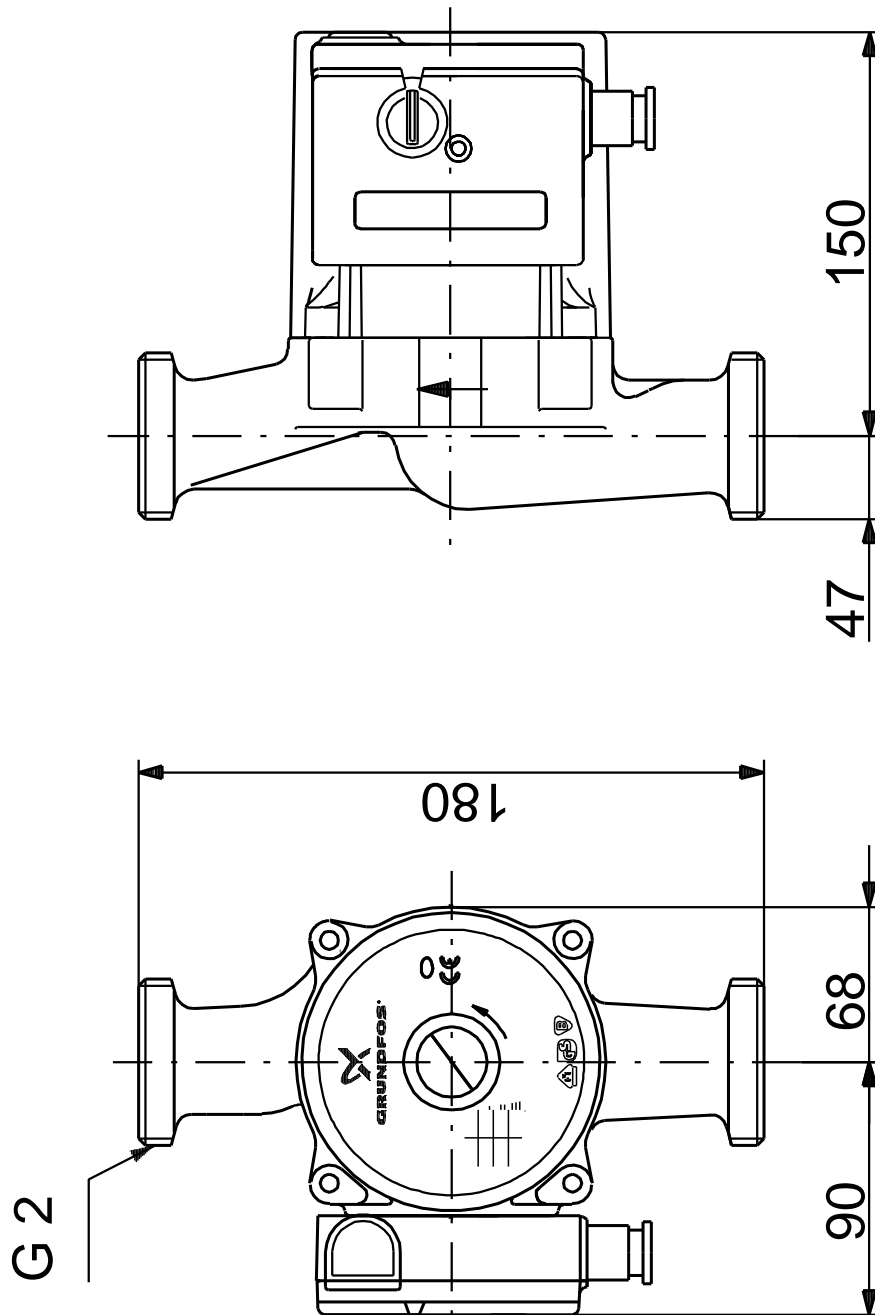

95906500 UPS 32-100 180 50

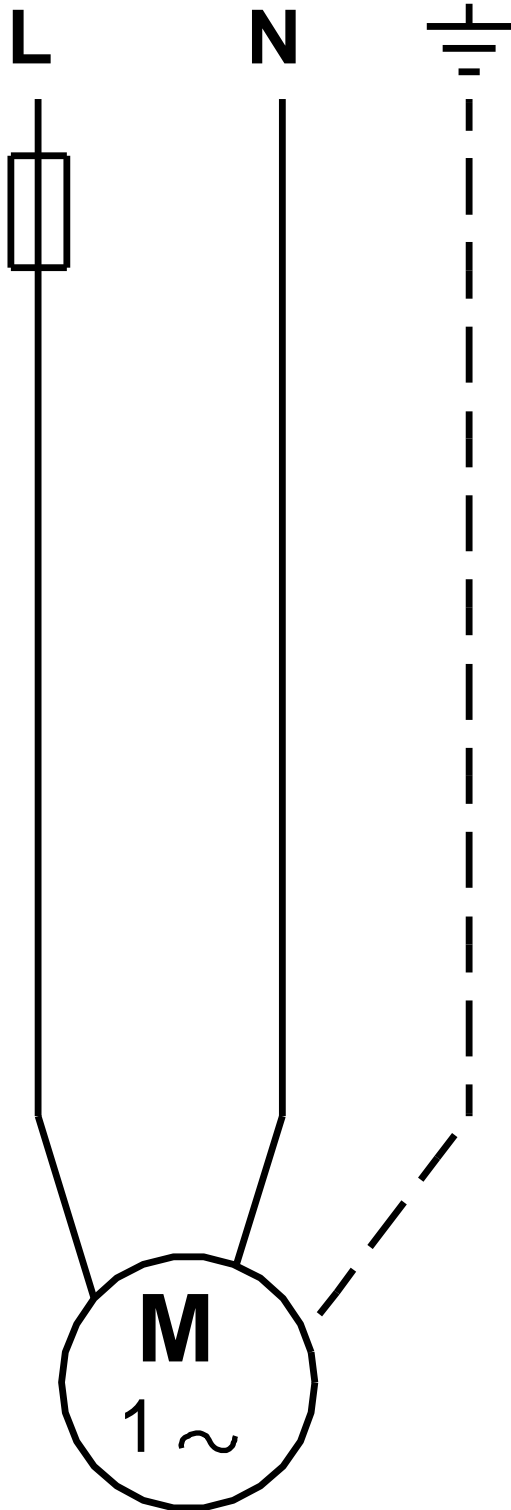

! []